

QD-10-50000-P-2S

0.01~50GHz

Features:

- * Broadband
- * High Sensitivity

Applications:

- * Telecom
- * Instrumentation
- * Laboratory Test
- * Radar

Electrical

Frequency Range:	0.01~50GHz
Sensitivity:	600V/W typ.
VSWR:	1.7 typ.
Input Power:	+10dBm typ.
Input Dynamic Range:	-20dBm min.
Polarity:	Positive
Impedance:	50Ω

Mechanical

Size ^{*1} :	12.7*10.16*10.16mm
	0.5*0.4*0.4in
Input Connector:	2.4mm Female
Output Connector:	SMA Female

[1] Exclude connectors.

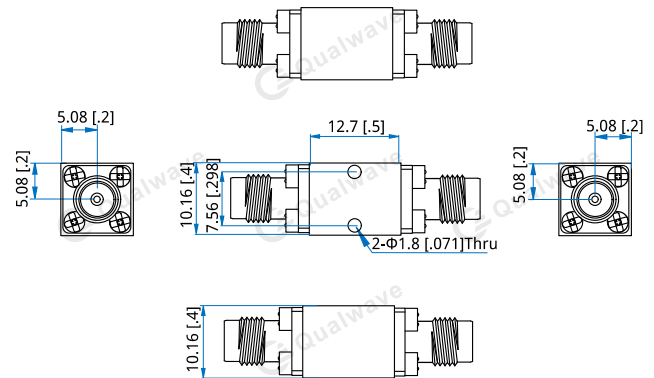
Outline Drawings

Unit: mm [in]

Tolerance: ±0.2mm [±0.008in]

How To Order
QD-10-50000-P-2S

Customization is available upon request.