

QLA-100-20000-30-40

0.1~20GHz, 30dB, 4dB

Features:
 * Broad Band
 * Low Noise

Applications:
 * Wireless
 * Receiver
 * Laboratory Test
 * Radar

Electrical

Frequency:	0.1~20GHz
Small Signal Gain:	30dB min.
Gain Flatness:	±2.5dB max.
Output Power (P1dB):	+17dBm min.
Noise Figure:	4dB max.
VSWR:	2 max.
Voltage:	+12V DC
Current:	270mA max.
Impedance:	50Ω

Mechanical

Size*1:	40*35*12mm 1.575*1.378*0.472in
RF Connectors:	SMA Female
Mounting:	4-Φ2.2mm through-hole

[1] Exclude connectors.

Environmental

Operating Temperature:	-40~+70°C
Non-operating Temperature:	-55~+100°C

Outline Drawings

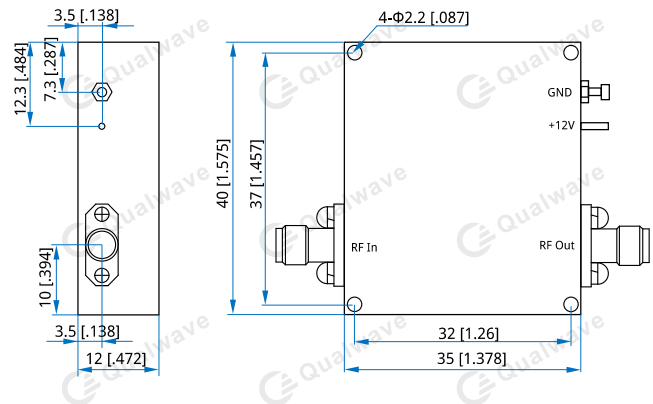

Unit: mm [in]

Tolerance: ±0.2mm [±0.008in]

How To Order

QLA-100-20000-30-40

Customization is available upon request.