

QLAS-100-12000-30-30

0.1~12GHz, 30dB, 3.0dB



Features:
 * Broadband
 * Low Noise

Applications:
 * Wireless
 * Receiver
 * Laboratory Test
 * Radar

Electrical

Frequency:	0.1~12GHz
Gain:	30dB typ.
Gain Flatness:	±1.5dB typ.
Output Power (P1dB):	15dBm typ.
Noise Figure:	3.0dB typ.
Spurious:	-60dBc max.
VSWR:	1.8 typ.
Voltage:	+85~+265V AC
Impedance:	50Ω

Mechanical

Size*2:	136*186*52mm
	5.354*7.323*2.047in
RF Connectors:	SMA Female

[2] Exclude connectors, rack mount brackets, handles.

Environmental

Operating Temperature:	-20~+50°C
Non-operating Temperature:	-40~+85°C

Absolute Maximum Ratings*1

RF Input Power:	+20dBm
-----------------	--------

[1] Permanent damage may occur if any of these limits are exceeded.

How To Order

QLAS-100-12000-30-30

Customization is available upon request.

Outline Drawings

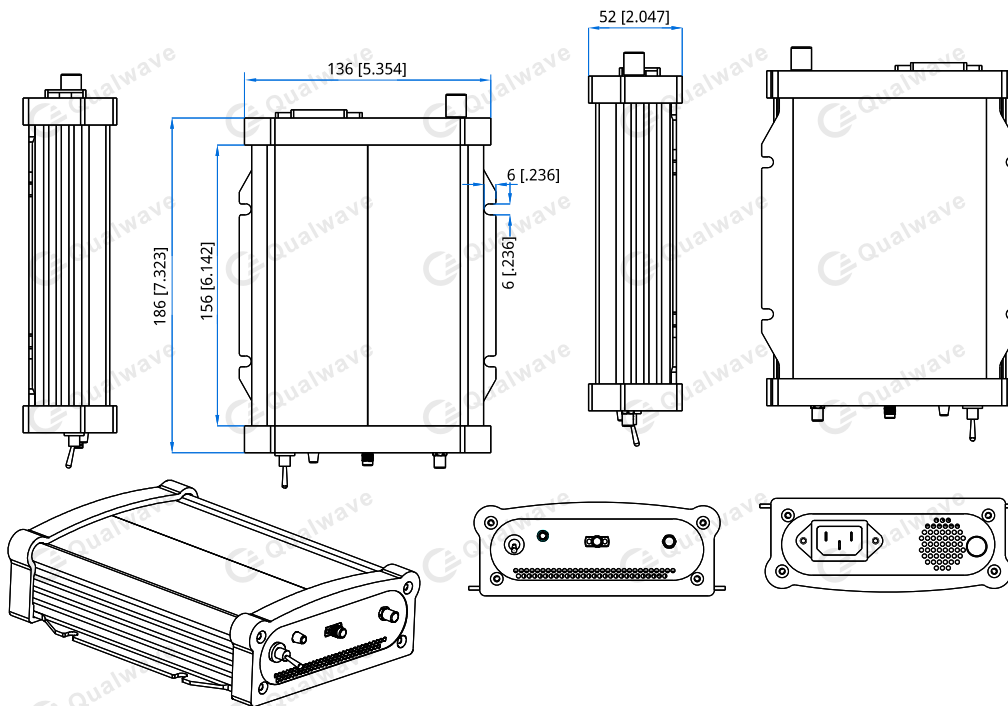

Unit: mm [in]

Tolerance: ±0.5mm [±0.02in]