

QLAS-100-18000-30-30

0.1~18GHz, 30dB, 3.0dB



Features:
* Broadband
* Low Noise

Applications:
* Wireless
* Receiver
* Laboratory Test
* Radar

Electrical

Frequency:	0.1~18GHz
Gain:	30dB typ.
Gain Flatness:	±1.5dB typ.
Output Power (P1dB):	15dBm typ.
Noise Figure:	3.0dB typ.
Spurious:	-60dBc max.
VSWR:	1.8 typ.
Voltage:	+85~+265V AC
Impedance:	50Ω

Mechanical

Size*2:	136*186*52mm 5.354*7.323*2.047in
RF Connectors:	SMA Female

[2] Exclude connectors, rack mount brackets, handles.

Environmental

Operating Temperature:	-20~+50°C
Non-operating Temperature:	-40~+85°C

Absolute Maximum Ratings*1

RF Input Power:	+20dBm
-----------------	--------

[1] Permanent damage may occur if any of these limits are exceeded.

How To Order

QLAS-100-18000-30-30

Customization is available upon request.

Outline Drawings

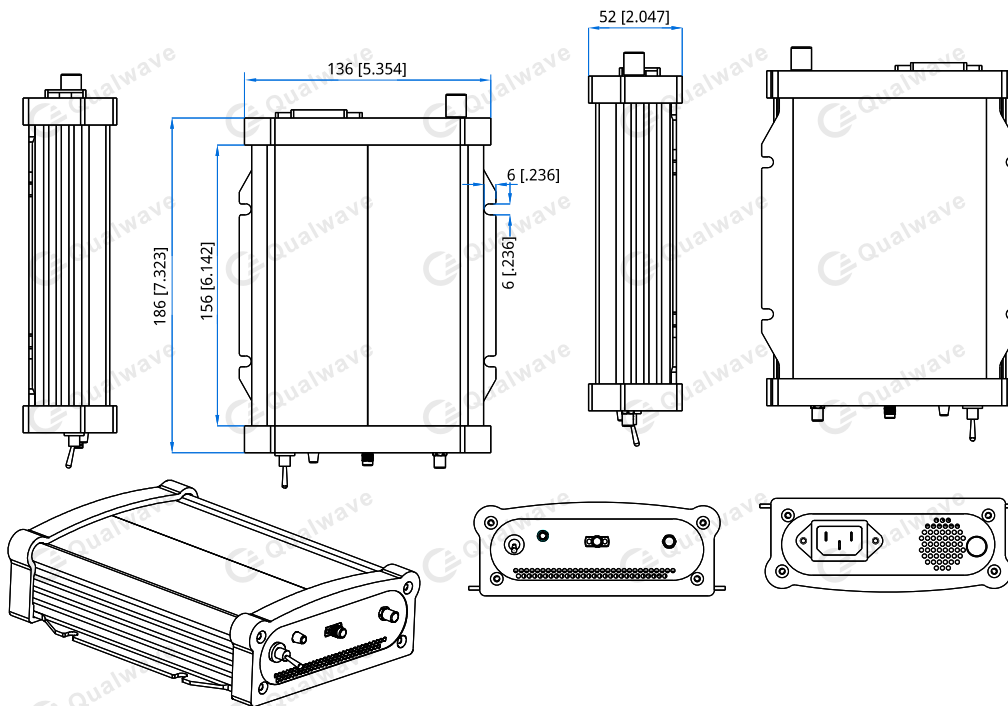

Unit: mm [in]

Tolerance: ±0.5mm [±0.02in]